



Rev. 20 - April 12th, 2024

## R14xxET R1570ET 19" & DT14xxET DT1570ET DeskTop HV Power Supplies



# Register your device

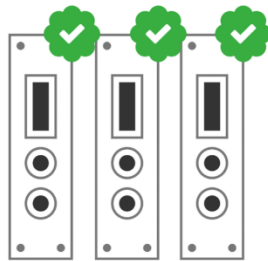
Register your device to your **MyCAEN+** account and get access to our customer services, such as notification for new firmware or software upgrade, tracking service procedures or open a ticket for assistance. **MyCAEN+** accounts have a dedicated support service for their registered products. A set of basic information can be shared with the operator, speeding up the troubleshooting process and improving the efficiency of the support interactions.

**MyCAEN+** dashboard is designed to offer you a direct access to all our after sales services. Registration is totally free, to create an account go to <https://www.caen.it/become-mycaenplus-user> and fill the registration form with your data.



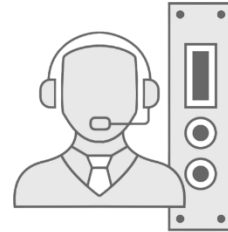
1

create a MyCAEN+ account



2

register your devices



3

get support and more!



<https://www.caen.it/become-mycaenplus-user/>

## Purpose of this User Manual



This document is the R14xxET R1570ET 19" & DT14xxET DT1570ET DeskTop HV Power Supplies User's Manual; it contains information about the installation, the configuration and the use of the device.

## Change Document Record

Date	Revision	Changes
3 February 2020	11	Updated Internal Settings, Remote Control, Technical specs. Table
9 March 2020	12	Updated Technical specs. Table
6 August 2020	13	Updated Technical specs. Table
20 October 2020	14	Ethernet settings (DHCP); available with fw release >2.10
12 February 2021	15	Updated ripple specs. Table
29 March 2021	16	Updated USB communication, Technical specs. Table, Remote Control
5 May 2021	17	Updated KILL, Interlock description
4 June 2021	18	Updated with data for R14xxETLV versions; Polarity selection
16 March 2023	19	Channel settings
12 April 2024	20	Updated Technical specs. Table

## Manufacturer Contacts



### CAEN S.p.A.

Via Vetraia, 11 55049 Viareggio (LU) - ITALY  
Tel. +39.0584.388.398 Fax +39.0584.388.959  
[www.caen.it](http://www.caen.it) | [info@caen.it](mailto:info@caen.it)

© CAEN SpA – 2023

## Limitation of Responsibility

If the warnings contained in this manual are not followed, CAEN will not be responsible for damage caused by improper use of the device. The manufacturer declines all responsibility for damage resulting from failure to comply with the instructions for use of the product. The equipment must be used as described in the user manual, with particular regard to the intended use, using only accessories as specified by the manufacturer. No modification or repair can be performed.

## Disclaimer

No part of this manual may be reproduced in any form or by any means, electronic, mechanical, recording, or otherwise, without the prior written permission of CAEN spa. The information contained herein has been carefully checked and is believed to be accurate; however, no responsibility is assumed for inaccuracies. CAEN spa reserves the right to modify its products specifications without giving any notice; for up to date information please visit [www.caen.it](http://www.caen.it).

## Made in Italy

We remark that all our boards have been designed and assembled in Italy. In a challenging environment where a competitive edge is often obtained at the cost of lower wages and declining working conditions, we proudly acknowledge that all those who participated in the production and distribution process of our devices were reasonably paid and worked in a safe environment (this is true for the boards marked "MADE IN ITALY", while we cannot guarantee for third-party manufactures).



## Index

Purpose of this User Manual .....	3
Change Document Record .....	3
Manufacturer Contacts.....	3
Limitation of Responsibility .....	3
Disclaimer .....	3
Made in Italy .....	3
<b>1 Safety Notices .....</b>	<b>6</b>
<b>2 General description .....</b>	<b>8</b>
Overview .....	8
<b>3 Technical specifications .....</b>	<b>9</b>
Dimensions .....	9
Power requirements .....	9
Front panel .....	9
External connections .....	10
Local control section .....	10
Channel control and output section.....	10
Channel control .....	10
Kill signal .....	11
HV Channel Output .....	11
HV Status control section .....	12
Alarm signal .....	12
Interlock signal.....	13
Remote communication control section.....	14
Preamplifier Output .....	14
Preamplifier References.....	15
AC Input (back plane).....	15
Technical specifications table .....	16
Voltage Ripple .....	17
Imon Zoom.....	17
<b>4 Operating modes.....</b>	<b>18</b>
Safety requirements .....	18
Initial inspection and installation.....	18
Local Control .....	19
BOARD Settings .....	19
Ethernet settings .....	20
Channel settings.....	21
Group Settings .....	22
Status Icon.....	23
Current monitor offset calibration .....	23
Remote Control .....	24
USB communication.....	24
Ethernet communication .....	24
Ethernet configuration .....	25
Firmware upgrade .....	26
Format EEPROM .....	27
Channels settings.....	27
Board Status .....	27
Communication Protocol .....	29
Command Format .....	29
Format of response string.....	29
MONITOR commands related to the Channels .....	29
Meaning of STATUS bits (value read in decimal Format).....	30
MONITOR commands related to the module .....	30
Meaning of Board Alarm bits .....	31
SET commands related to the Channels.....	31
SET commands related to the module .....	31
EPICS Service.....	31
<b>5 Internal Settings .....</b>	<b>33</b>

Polarity selection .....	33
Local Bus termination .....	35
Grounding specifications .....	35
Safety Earth connection .....	35
<b>6 Instructions for Cleaning.....</b>	<b>37</b>
Cleaning the Touchscreen .....	37
Cleaning the air vents .....	37
General cleaning safety precautions .....	37
<b>7 Device decommissioning .....</b>	<b>38</b>
<b>8 Disposal .....</b>	<b>39</b>
<b>9 Technical Support.....</b>	<b>40</b>

## List of Figures

Fig. 1: Mod. R14xx-1570ET and DT14xx-1570ET.....	8
Fig. 2: DT14xxET Front panel .....	9
Fig. 3: R14xxET Front panel (4 channel).....	9
Fig. 4: R14xxET Front panel (8 channel).....	9
Fig. 5: DT1570ET Front panel.....	9
Fig. 6: R1570ET Front panel (4 channel) .....	9
Fig. 7: R14xxETLV Front panel.....	10
Fig. 8: Local control panel.....	10
Fig. 9: Channel control panel and Kill scheme .....	10
Fig. 10: KILL electrical scheme .....	11
Fig. 11: HV Channel panel and test point electrical scheme.....	11
Fig. 12: HV Status control panel.....	12
Fig. 13: ALARM electrical scheme.....	12
Fig. 14: ALARM TTL configured .....	13
Fig. 15: INTERLOCK electrical scheme.....	13
Fig. 16: Remote communication control and RS485 I/O – RS232 IN electrical scheme.....	14
Fig. 17: Preamp LV Out .....	14
Fig. 18: Preamp GND/EARTH .....	15
Fig. 19: AC Input socket .....	15
Fig. 20: Main Menu.....	19
Fig. 21: Board Parameters .....	19
Fig. 22: Channel Parameters.....	21
Fig. 23: Virtual keypad .....	21
Fig. 24: Group Parameters.....	22
Fig. 25: Zoom Mode.....	22
Fig. 26: USB communication diagram .....	24
Fig. 27: Ethernet communication diagram .....	24
Fig. 28: Terminal Board Menu .....	25
Fig. 29: Terminal Ethernet settings.....	25
Fig. 30: Terminal Ethernet connection .....	26
Fig. 31: Firmware Upgrade Menu .....	26
Fig. 32: Format EEPROM Menu .....	27
Fig. 33: Channels Menu .....	27
Fig. 34: General Board Status .....	28
Fig. 35: Polarity selection instructions.....	34
Fig. 36: Dip switch position.....	35
Fig. 37: C21 jumper location.....	35
Fig. 38: Earth configuration connection examples .....	36





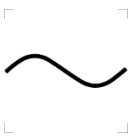

## List of Tables

Table 1: Available versions .....	8
Table 2: Kill operation.....	11
Table 3: Interlock operation .....	13
Table 4: Mod. R-DT14xxET – 1570ET Series technical specifications.....	16
Table 5: Mod. R-DT14xxET – 1570ET ripple specifications .....	17


# 1 Safety Notices

**N.B. Read carefully the “SAFETY, STORAGE AND SETUP INFORMATION PRODUCT SUPPORT SERVICE AND REPAIR” document provided with the product before starting any operation.**

The following HAZARD SYMBOLS may be reported on the unit:

	Caution, refer to product manual
	Caution, risk of electrical shock
	Protective conductor terminal
	Earth (Ground) Terminal
	Alternating Current
	Three-Phase Alternating Current

The following symbol may be reported in the present manual:

	General warning statement
---	---------------------------

The symbol could be followed by the following terms:

- **DANGER:** indicates a hazardous situation which, if not avoided, will result in serious injury or death.
- **WARNING:** indicates a hazardous situation which, if not avoided, could result in death or serious injury.
- **CAUTION:** indicates a situation or condition that, if not avoided, could cause physical injury or damage the product and / or its environment.

CAUTION: To avoid potential hazards



**USE THE PRODUCT ONLY AS SPECIFIED.  
ONLY QUALIFIED PERSONNEL SHOULD PERFORM SERVICE PROCEDURES**

CAUTION: Avoid Electric Overload



**TO AVOID ELECTRIC SHOCK OR FIRE HAZARD, DO NOT POWER A LOAD  
OUTSIDE OF ITS SPECIFIED RANGE**

CAUTION: Avoid Electric Shock



**TO AVOID INJURY OR LOSS OF LIFE, DO NOT CONNECT OR DISCONNECT  
CABLES WHILE THEY ARE CONNECTED TO A VOLTAGE SOURCE**

CAUTION: Do Not Operate without Covers



**TO AVOID ELECTRIC SHOCK OR FIRE HAZARD, DO NOT OPERATE THIS  
PRODUCT WITH COVERS OR PANELS REMOVED**

CAUTION: Do Not Operate in Wet/Damp Conditions



**TO AVOID ELECTRIC SHOCK, DO NOT OPERATE THIS PRODUCT IN WET  
OR DAMP CONDITIONS**

CAUTION: Do Not Operate in an Explosive Atmosphere



**TO AVOID INJURY OR FIRE HAZARD, DO NOT OPERATE THIS PRODUCT  
IN AN EXPLOSIVE ATMOSPHERE**



**THIS DEVICE SHOULD BE INSTALLED AND USED BY SKILLED TECHNICIAN  
ONLY OR UNDER HIS SUPERVISION**



**DO NOT OPERATE WITH SUSPECTED FAILURES.  
IF YOU SUSPECT THIS PRODUCT TO BE DAMAGED, PLEASE CONTACT  
THE TECHNICAL SUPPORT**

# 2 General description

## Overview



**Fig. 1: Mod. R14xx-1570ET and DT14xx-1570ET**

This HV power supply family provides 2, 4 or 8 independent High Voltage channels in either 19" rack unit package or Desktop format. The units are 110/220V AC Powered; five output ranges are available.

**Table 1: Available versions**

Series	1419	1470	1471	1471H	1570
V Full Scale (kV)	± 0.5	± 8	± 5.5	± 5.5	±15
I Full Scale (mA)	0.2	3 (@3kV)	0.3	0.02	1
Output Connectors	SHV	SHV	SHV	SHV	HV LEMO
Available format	19" 4-8ch; DT 4ch	19" 4-8ch; DT 4ch	19" 4-8ch; DT 4ch	19" 4-8ch; DT 4ch	19" 2-4ch; DT 2ch

Module control can take place either locally, assisted by a 2.8" Touchscreen Graphic color LCD display or remotely, via USB, or Ethernet, the latter allowing to build a daisy chain network. The output polarity is independently selectable for each channel.

Channels have common floating return (common return insulated from the crate ground), that can be configured as "common ground" (see p.34); HV outputs are delivered through SHV connectors (HV LEMO for 1570 series).

Two special versions, R1470ETLV and R1471ETLV, also include four preamplifier power supplies (±12V and ±24V) on four SUBD9 connectors.

Safety features include:





- OVERVOLTAGE and UNDERVOLTAGE warning when the output voltage differs from the programmed value by more than 2% of set value (minimum 10V).
- Programmable VMAX protection limit
- OVERCURRENT detection: if a channel tries to draw a current larger than its programmed limit, it enters TRIP status, keeping the maximum allowed value for a programmable time (TRIP), before being switched off
- Common Interlock logic for channels enable/disable and individual inputs signal for channel Kill function.

# 3 Technical specifications

## Dimensions

- 19" rack (height: 2U; depth: 360mm). Weight: ~9kg (2-4 ch), 10.5kg (8 ch).
- Desktop (239x84x184mm); Weight: ~5.2kg.

## Power requirements

<p>2 Channels:</p> <p><b>VOLTAGE</b> 100 - 240 V ~ </p> <p><b>FREQUENCY</b> 50 / 60 HZ</p> <p><b>CURRENT</b> 0.6A RMS MAX</p> <p><b>FUSE</b> 2 x T1A 6.3x32 250VAC</p>	<p>4 Channels:</p> <p><b>VOLTAGE</b> 100 - 240 V ~ </p> <p><b>FREQUENCY</b> 50 / 60 Hz</p> <p><b>CURRENT</b> 0.8A RMS MAX</p> <p><b>FUSE</b> 2 x T1A 6.3x32 250VAC</p>	<p>4 Channels ETLV:</p> <p><b>VOLTAGE</b> 220 - 240 V ~ </p> <p><b>FREQUENCY</b> 50 HZ</p> <p><b>CURRENT</b> 0.8A RMS MAX</p> <p><b>FUSE</b> 2 x T1A 6.3x32 250VAC</p>	<p>8 Channels:</p> <p><b>VOLTAGE</b> 100 - 240 V ~ </p> <p><b>FREQUENCY</b> 50 / 60 Hz</p> <p><b>CURRENT</b> 1.6A RMS MAX</p> <p><b>FUSE</b> 2 x T2A 6.3x32 250VAC</p>
---	---	---	---

## Front panel



Fig. 2: DT14xxET Front panel



Fig. 3: R14xxET Front panel (4 channel)



Fig. 4: R14xxET Front panel (8 channel)



Fig. 5: DT1570ET Front panel



Fig. 6: R1570ET Front panel (4 channel)

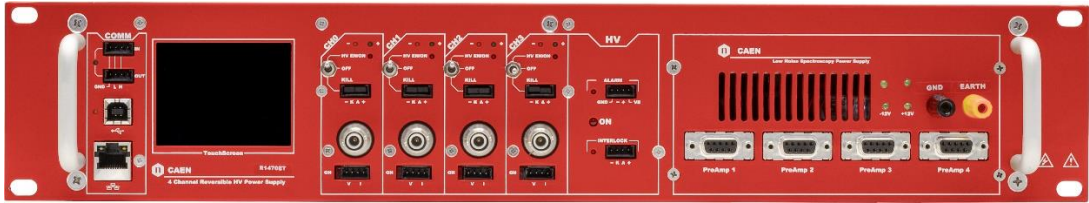


Fig. 7: R14xxETLV Front panel

## External connections

### Local control section



Fig. 8: Local control panel

<b>NAME:</b>	<b>TYPE:</b>	<b>FUNCTION:</b>
MONITOR	2.8" LED Touch Screen	Parameter and Mode setting; Local settings monitoring

### Channel control and output section

#### Channel control

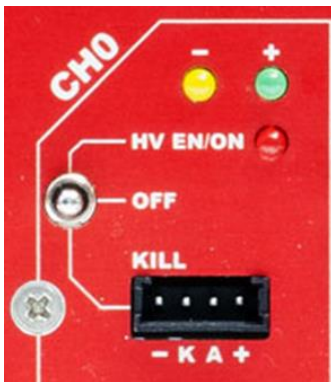
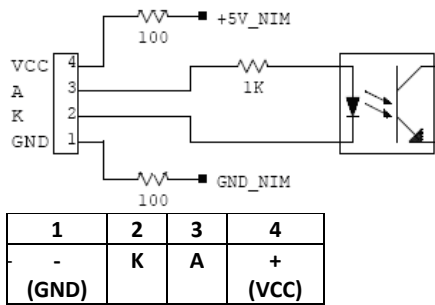


Fig. 9: Channel control panel and Kill scheme

<b>NAME:</b>	<b>TYPE:</b>	<b>FUNCTION:</b>
HV_EN/OFF/KILL	3 POS. SWITCH	Channel Enable and turning OFF/KILL
ON	RED LED	HV On enabled
+	GREEN LED	Positive polarity
-	YELLOW LED	Negative polarity
REMOTE KILL	AMP 280371-2	See below

### Kill signal



**Fig. 10: KILL electrical scheme**

A schematic diagram of the Kill input is shown in the figure above, where the diode is part of opto-coupler stage. Kill means that channels are hardware turned off. The following table explains the Kill operation:

**Table 2: Kill operation**

CONFIGURATION ↓	KILL MODE →	OPEN	CLOSE
leave contact open		Killed	ENABLED
voltage level (0÷1V, ~5mA current) between pin 2 (high) and pin 3 (low)		Killed	ENABLED
short circuit pin 1 with pin 2, and pin 3 with pin 4		ENABLED	Killed
voltage level (4÷6V, ~5mA current) between pin 2 (high) and pin 3 (low)		ENABLED	Killed

### HV Channel Output



**Fig. 11: HV Channel panel and test point electrical scheme**

<b>NAME:</b>	<b>TYPE:</b>	<b>FUNCTION:</b>
MON	AMP 280371-2	<i>Vout/Iout Test point</i>
OUT	<b>1419, 1470, 1471, 1471H</b> SHV RADIALL R317580 Impedance: 50 Ohm; Frequency range: 0 – 2 GHz; VSWR: <1.20 + 0.3 F (GHz) – (plug and jack); Test voltage: 10kV DC – 1mn (unmated connectors); Ratings: 12kV DC – 1mn (mated pairs); Current rating: 10 A	<i>HV Channel Output</i>
	<b>1570</b> LEMO HV ERA3S415CTL Endurance (Shell): 5000 mating cycles, Temp (min / max): -55°C / +250°C, Humidity (max): <=95% [at 60 deg C /140 F], Vibration: 15 g [10 Hz - 2000 Hz], Shock Resistance: 100 g [ 6 ms], Salt Spray Corrosion: >144 hr, Climatical Category: 50/175/21 Shielding (min): 75 dB (10 MHz) Shielding (min): 40 dB (1 GHz), IP Rating: 50	



WARNING! These connectors produce extremely hazardous high voltages at a potentially lethal current level; never connect or disconnect the HV OUT connector with the power ON/OFF switch ON; always switch power OFF and wait at least 30s before connecting or disconnecting HV cables.

The test points allow to monitor the Channel Output Voltage and Current according to the following conversion:

<b>VMON</b>	R-DT1419ET	Voltage level	1V = 118 V $\pm$ 1% readout; same polarity as channel
	R-DT1470ET		1V = 1.8V $\pm$ 1% readout; same polarity as channel
	R-DT1471ET		1V = 1.5 kV $\pm$ 1% readout; same polarity as channel
	R-DT1471HET		1V = 1.5 kV $\pm$ 1% readout; same polarity as channel
	R-DT1570ET		1V = 4 kV $\pm$ 1% readout; same polarity as channel
<b>IMON HI RANGE</b>	R-DT1419ET		1V = 67 $\mu$ A $\pm$ 3% readout; positive, 0÷5 V range
	R-DT1470ET		1V = 660 $\mu$ A $\pm$ 3% readout; positive, 0÷5 V range
	R-DT1471ET		1V = 66 $\mu$ A $\pm$ 3% readout; positive, 0÷5 V range
	R-DT1471HET		1V = 4.55 $\mu$ A $\pm$ 3% readout; positive, 0÷5 V range
	R-DT1570ET		1V = 260 $\mu$ A $\pm$ 3% readout; positive, 0÷5 V range
<b>IMON LOW RANGE</b>	R-DT1419ET		1V = 6.7 $\mu$ A $\pm$ 3% readout; positive, 0÷5 V range
	R-DT1470ET		1V = 66 $\mu$ A $\pm$ 3% readout; positive, 0÷5 V range
	R-DT1471ET		1V = 6.6 $\mu$ A $\pm$ 3% readout; positive, 0÷5 V range
	R-DT1471HET		1V = 455 nA $\pm$ 3% readout; positive, 0÷5 V range
	R-DT1570ET		1V = 26 $\mu$ A $\pm$ 3% readout; positive, 0÷5 V range

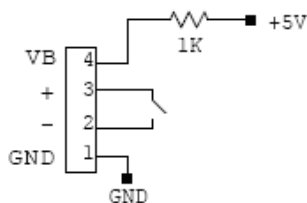
### HV Status control section



**Fig. 12: HV Status control panel**

NAME:	TYPE:	SIGNAL:	FUNCTION:
ON	RED LED		HV On enabled (at least one channel ON)
ALARM	RED LED/ AMP 280371-2.	Out	Alarm status signalled (active LOW)
INTERLOCK	RED LED/ AMP 280371-2	In	Interlock signal

### Alarm signal



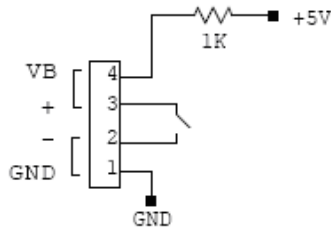
**Fig. 13: ALARM electrical scheme**

As an Alarm condition is detected (see p. 30 and 31) pins 2 and 3 (- and +) are closed; the contact can be used to switch an external device supplied by an external source, otherwise the VB and GND references can be used to provide a TTL compatible level on pin 2 and 3.

In the first case (externally supplied device) the maximum allowed ratings are:

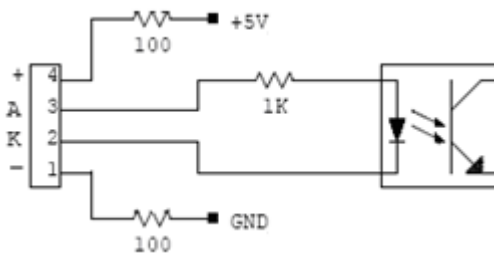
- Maximum voltage between + and -: 12V
- Maximum sink current across + and -: 100mA

In the latter case, to produce a TTL compatible Alarm Out, pin 3 (+) must be connected with pin 4 (VB) and pin 1 (GND) with pin 2 (-); see the diagram below:



**Fig. 14: ALARM TTL configured**

**Interlock signal**



1	2	3	4
-	K	A	+
(GND)			(VCC)

**Fig. 15: INTERLOCK electrical scheme**

A schematic diagram of the Interlock input is shown in the figure above, where the diode is part of optocoupler stage.

Interlock means that channels are hardware disabled. The following table explains the interlock operation:

**Table 3: Interlock operation**

CONFIGURATION ↓	INTERLOCK MODE →	OPEN	CLOSE
leave contact open		INTERLOCK	ENABLED
voltage level (0÷1V, ~5mA current) between pin 2 (high) and pin 3 (low)		INTERLOCK	ENABLED
short circuit pin 1 with pin 2, and pin 3 with pin 4		ENABLED	INTERLOCK
voltage level (4÷6V, ~5mA current) between pin 2 (high) and pin 3 (low)		ENABLED	INTERLOCK

The front panel Interlock LED is ON when the INTERLOCK is active; as INTERLOCK is active, channels are turned off at the fastest available rate, regardless the RAMP DOWN setting.

Remote communication control section

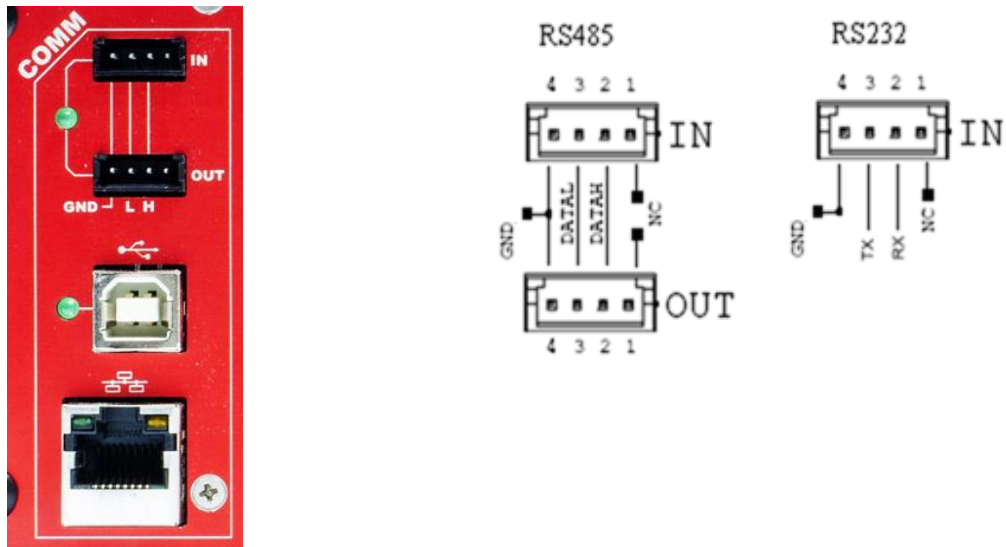


Fig. 16: Remote communication control and RS485 I/O – RS232 IN electrical scheme

NAME:	TYPE:	FUNCTION:
IN	AMP 280371-2	RS485 Input <sup>1</sup> ;
OUT	AMP 280371-2	RS485 Output
USB	B TYPE USB	USB2.0 compliant
ETH	10Base-T female connector	TTL signals (TCP/IP)

Preamplifier Output

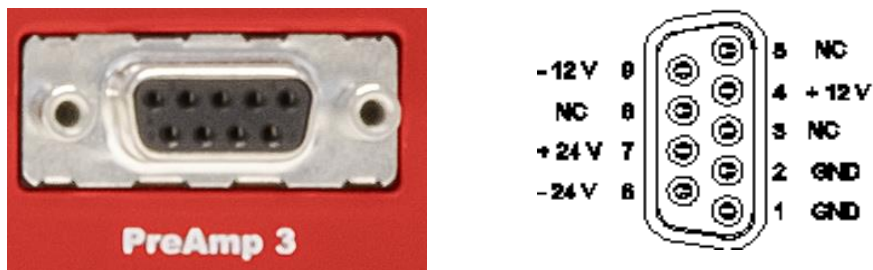


Fig. 17: Preamp LV Out

NAME:	TYPE:	SIGNAL:
PreAmp 1,2,3,4	4 SubD9 female connectors	100mA @±12V; 50mA @±24 V output

<sup>1</sup> RS 485 Serial Port Interface allows to control up to 32 modules connected by a twisted pair cable; the first and last modules must be terminated, see p.36; this feature is not available on Mod. R1470ETD - (8 Channel)

## Preamplifier References



**Fig. 18: Preamp GND/EARTH**

NAME:	TYPE:	FUNCTION:
GND	Industrial Terminal for 4mm plug and wire connection up to 2mm $\varnothing$ (black)	$\pm 12V$ ; $\pm 24V$ power supply return
EARTH	Industrial Terminal for 4mm plug and wire connection up to 2mm $\varnothing$ (yellow)	Mains EARTH

## AC Input (back plane)



**Fig. 19: AC Input socket**

IEC 60 320 Socket with switch; to be connected to Mains 100 - 240 Vac (50 - 60 Hz) via provided power cord.

Two Fuses: 6.3x32 (2/4 channels: 1A, 8 channels: 2A); Retarded 250VAC

## Technical specifications table

**Table 4: Mod. R-DT14xxET – 1570ET Series technical specifications**

Series	1419	1471H	1471	1470	1570	
Dimensions	19" rack (h: 2U; d: 360mm). Weight: ~9kg (2-4 ch), 10.5kg (8 ch & R14xxETLV); Desktop (239x84x184mm); Weight: ~5.2kg					
Number of channels	4 or 8				2 or 4	
Output connectors	SHV				HV LEMO	
Power requirements	100–240V ~ 50/60Hz; 2 ch.: 0.6A RMS; fuse 2xT1A 6.3x32 250VAC; 4 ch.: 0.8A RMS; fuse 2xT1A 6.3x32 250VAC; 8 ch.: 1.6A RMS; fuse 2xT2A 6.3x32 250VAC. See also page 9					
Output channels	Positive or Negative Polarity (requires internal setting, see p. 33)					
Output ranges	500 V / 200µA	5.5kV / 20µA	5.5kV / 300µA	8 kV / 3 mA	15 kV / 1mA	
Max. Ch. Output Power	0.1W	0.11W	1.65W	9 W ( Vset ≤ 3 kV) 8 W ( Vset > 3 kV)	10W (<10kV) 7W (>10kV)	
Vset / Vmon Resolution	10 mV	100 mV		200 mV	500 mV	
Iset Resolution	5 nA	1 nA	5 nA	50 nA	20 nA	
Imon Resolution	IMON RNG H	5 nA	1 nA	5nA	20 nA	
	IMON RNG L	500pA	50pA	500pA	2 nA	
Vmax	0 ÷ 510 V	0 ÷ 5600 V		0 ÷ 8100 V	0 ÷ 15100 V	
	Absolute maximum HV level that the channel is allowed to reach, independently from the preset value Vset. Output voltage cannot exceed the preset value Vmax. The accuracy is 1% ± 5 V					
Vmax resolution	± 0.1 V	± 1 V				
Alarm output	Open collector, 100 mA maximum sink current					
Interlock input	LOW: <1V; current~5mA; HIGH: 4÷6 V					
Ramp Up/Down	1÷50 Volt/s, 1 Volt/s step		1÷500 Volt/s, 1 Volt/s step			
Trip	Max. time an "overcurrent" is allowed to last (seconds). A channel in "overcurrent" works as a current generator; output voltage varies in order to keep the output current lower than the programmed value. "Overcurrent" lasting more than set value (1 to 9999) causes the channel to "trip". Output voltage will drop to zero either at the Ramp-down rate or at the fastest available rate, depending on Power Down setting; in both cases the channel is put in the off state. If trip= INFINITE, "overcurrent" lasts indefinitely. TRIP range: 0 ÷ 999.9 s; 1000 s = Infinite. Step = 0.1 s					
"Zero" current	Zero Current Detect channel parameter allows to sample the present IMon value; this value (IMonZero) can be then subtracted via the Zero Current Adjust parameter ENABLE, from the monitored current (IMon), to compensate the current offset; if ZCAjust = Enabled, then the IMon value is compensated. After the IMonZero value is sampled, Zero Current Detect, returns to Off. Allowed IMonZero values are from 0 to full scale. If Zero Current Adjust is DISABLED, the IMonZero compensation is neglected. (Available only on 1471H series)					
Accuracy <sup>2</sup>	Vmon vs. Vout	±0.02% of read value ±0.2V		±0.02% of read value ±2V		
	Vset vs. Vout	±0.02% of set value ±0.2V		±0.02% of set value ±2V		
	Imon vs. Iout	IMON RNG H	±2% of read ±20nA	±2% of read ±2nA	±2% of read ±20nA	±2% of read ±2µA
		IMON RNG L	±2% of read ±2nA	±2% of read ±200pA	±2% of read ±2nA	±2% of read ±200nA
	Iset vs. Imon	IMON RNG H	±2% of read ±30nA	±2% of read ±3nA	±2% of read ±30nA	±2% of read ±2µA
IMON RNG L		±2% of read ±3nA	±2% of read ±300pA	±2% of read ±3nA	±2% of read ±200nA	
Voltage Ripple	See page 17					
PreAmp 1,2,3,4 (R14xxETLV)	N.A.		100mA@±12V; 50mA@±24V		N.A.	
Ventilation Fan	60x60 24V; 62 dBA maximum noise level					
Humidity range	0 ÷ 80%					
Operating temperature	0 ÷ 45°C					
Storage temperature	-10 ÷ 70°C					
Altitude	Not designed for high altitude (2000mt max.)					
Vout / Temperature coeff.	max. 50ppm / °C					
Imon / Temperature coeff.	max 100ppm/C°; max 300ppm/C° with Imon zoom <sup>3</sup>					
Longterm stab. Vout vs. Vset	± 0.02% (after one week @ constant temperature)					
Mean time between failures	~12 years					
EMC qualification	CEI EN 61326					

<sup>2</sup> Accuracy values are measured from 10% to 90% of Full Scale Range

<sup>3</sup> Typical data (for NDT1470/N1470ET) IMON: Imon-Zoom Offset = ±100nA; ppm/C° Imon-Zoom <300ppm/C°; Imon leakage +5nA/2kV

## Voltage Ripple

Table 5: Mod. R-DT14xxET – 1570ET ripple specifications

Series	1419	1470			1471	1471H	1570				
Range	Full scale	3kV/200µA	3kV/3mA	8kV/800µA	Full scale	Full scale	7 kV/250µA	10 kV/350µA	14 kV/500µA		
Bandwidth	20 ÷ 1000 Hz	Typ	<5 mVpp	<20 mVpp	<20 mVpp	<25 mVpp	<10 mVpp	<12 mVpp	<7 mVpp	<12 mVpp	<20 mVpp
		Max	<10 mVpp	<25 mVpp	<30 mVpp	<30 mVpp	<15 mVpp	<20 mVpp	<10 mVpp	<15 mVpp	<25 mVpp
	1 ÷ 20000 kHz	Typ	<3 mVpp	<5 mVpp	<5 mVpp	<10 mVpp	<3 mVpp	<2 mVpp	<4 mVpp	<6 mVpp	<20 mVpp
		Max	<5 mVpp	<10 mVpp	<10 mVpp	<15 mVpp	<8 mVpp	<5 mVpp	<10 mVpp	<15 mVpp	<25 mVpp

## Imon Zoom

Imon Zoom is a feature that allows to monitor the channel current with an increased resolution in the following ranges:

1419	0 – 20 µA
1470	0 – 300 µA
1471	0 – 30 µA
1471H	0 - 2 µA
1570	0 – 100 µA

by selecting Imon Range = LOW, the output current is monitored with

1419	500 pA resolution (instead of 5 nA), in the 0 – 20 µA range
1470	5 nA resolution (instead of 50 nA), in the 0 – 300 µA range
1471	500 pA resolution (instead of 5 nA), in the 0 – 30 µA range
1471H	50 pA resolution (instead of 1 nA), in the 0 - 2 µA range
1570	2 nA resolution (instead of 20 nA), in the 0 – 100 µA range

It is important to notice that, if Imon Range = LOW is selected, and the channel draws a current larger than

20 µA	1419
300 µA	1470
30 µA	1471
2 µA	1471H
100 µA	1570

then Overcurrent is signalled.

# 4 Operating modes

## Safety requirements

**N.B. read carefully the “Precautions for Handling, Storage and Installation” document provided with the product before starting any operation!**

The following HAZARD SYMBOLS are reported on the unit:



**CAUTION:** indicates the need to consult the “Precautions for Handling, Storage and Installation” document provided with the product. **A potential risk exists if the operating instructions are not followed**



**HIGH VOLTAGE:** indicates the presence of electric shock hazards. Enclosures marked with these symbols should only be opened by CAEN authorized personnel.

**To avoid risk of injury from electric shock, do not open this enclosure**

To avoid potential hazards, use the product only as specified. Only qualified personnel should perform service procedures.

**Avoid Electric Overload.** To avoid electric shock or fire hazard, do not power a load outside of its specified range.

**Avoid Electric Shock.** To avoid injury or loss of life, do not connect or disconnect cables while they are connected to a voltage source.

**Do Not Operate without Covers.** To avoid electric shock or fire hazard, do not operate this product with covers or panels removed.

**Do Not Operate in Wet/Damp Conditions.** To avoid electric shock, do not operate this product in wet or damp conditions.

**Do Not Operate in an Explosive Atmosphere.** To avoid injury or fire hazard, do not operate this product in an explosive atmosphere.

**Do Not Operate with Suspected Failures.** If you suspect this product to be damaged, have it inspected by qualified service personnel.

## Initial inspection and installation

Prior to shipment, these units are inspected and found free of mechanical or electrical defects. Upon unpacking of the unit, inspect for any damage, which may have occurred in transport. The inspection should confirm that there is no exterior damage to the unit, such as broken knobs or connectors, and that the panels are not scratched or cracked. Keep all packing material until the inspection has been completed. If damage is detected, file a claim with carrier immediately and notify CAEN. Before installing the unit, make sure you have read thoroughly the safety rules and installation requirements, then place the package content onto your bench; you shall find the following parts:



R14xxET's – R1570ET's are housed in 19" rack package. The R14xxET– R1570ET is an equipment for BUILDING-IN: it must be installed in a 19" EIA compliant equipment rack. Use the front panel rack-mount

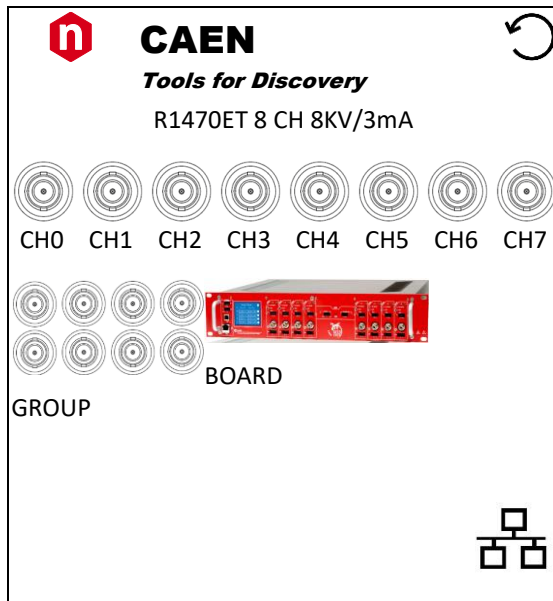
brackets to install the unit in the rack, using standard screws; leave at least one rack unit of free space above and below the Unit.

DT14xxET's DT1570ET's are housed in a Desktop package. The DT14xxET– DT1570ET is an equipment for BUILDING-IN: it must be used on flat solid surfaces, such as a table.

Unit control can take place either locally, assisted by a 2.8" Touchscreen LCD or remotely, via USB, or Ethernet (see p. 24).

## Local Control

To turn ON the unit, connect the unit to the Mains through the power cord, provided with the kit, and switch it ON. At power ON the Display shows the Main Menu:



**Fig. 20: Main Menu**

At this point the module is ready to be operated locally. Tap on:

- BOARD icon to access BOARD parameters
- CHx icon to access CHANNELS parameters
- GROUP icon to access CHANNEL GROUP parameters

## BOARD Settings

Board Parameters	
Power	√
RTerm	Off
HV Clock	√
LBusBaud	9600
LBusAddr	0
Interlock	Closed
Control	Remote
←	

**Fig. 21: Board Parameters**

General board parameters (CONTROL can be operated both in LOCAL and REMOTE mode; other settings are allowed in LOCAL mode only; monitor options are available also with remote control) include:

**Parameter:**            **Type:**            **Function:**

Power	Monitor	Module power supply status
Termination	Monitor	Local Bus termination status (ON/OFF)
HV Clock	Monitor	Sync clock frequency (200±10 kHz correct value)
Local Bus Baud Rate	Monitor/Set	9600, 19200, 38400, 57600, 115200 Baud
Local Bus Address	Monitor/Set	Local Bus address for remote communication (0÷31)
INTERLOCK	Monitor/Set	CLOSED / OPEN OPERATION (see p.13)
<b>CONTROL</b>	Monitor/Set	REMOTE: the module is controlled remotely; local monitor is allowed; <i>LOCAL/REMOTE</i> switch is enabled LOCAL: the module is controlled locally; remote monitor is allowed

To set one parameter, set Control to “Local”, then tap on the relevant name, and change and/or enter the desired value; confirm with “Enter”.

Tapping the red arrow, allows to go back.

Tapping “Network” Icon allows to access Ethernet configuration menu:

**Ethernet settings**

<b>Ethernet Config. Menu</b> <
<b>IPAddress</b>
<b>010.000.007.061</b>
<b>Mask</b>
<b>255.000.000.000</b>
<b>Gateway</b>
<b>255.255.255.255</b>
✓ >

<b>MAC Address</b>
<b>010.000.000.000</b>
<b>DHCP</b>
<b>Disabled</b>
✓ >

This option allows to configure the Ethernet settings; once they are done, tap Mark icon to Save, but changes will only become effective at next power ON. Tap the red arrows to go forward and back.

If a DHCP Server is available, then the module can be enabled or disabled as DHCP client; tap green button to save the new setting and go back to Main Menu: the DHCP server will automatically assign a new IP to the module at next Power On. Tap the backward red arrow to go back without changes.

Channel settings

(-) CH1 MENU ←		(-) CH1 MENU ←	
VMon	0000.0	MaxV	8100
IMon	0000.00	RampUp	500
Status	Kill !	RampDown	400
VSet	2000.0	Trip	INF
ISet	3100.00	PowerDown	Kill
Chan	1/2	IMonRange	High
		Chan	2/2

**Fig. 22: Channel Parameters**

For each channel the following parameters can be programmed and monitored either locally or remotely (see p.24):

Parameter:	Function:	Unit:
(±)	Channel polarity	
Vmon	High Voltage Monitored value	Volt
Imon	Current Monitored value	µA
Status	ON/OFF; Ramp UP/DOWN; OV; UNV; OVC; OVP; MAXV; TRIP; OVT; OFF; KILL; ILK; CAL_ERR	
Vset	High Voltage programmed value	Volt
Iset	Current Limit programmed value	µA
MaxV	Absolute maximum High Voltage level that the channel can reach (see p. 16)	V
Ramp-Up	Maximum High Voltage increase rate	V/s
Ramp-Down	Maximum High Voltage decrease rate	V/s
Power Down	Power Down mode after channel TRIP	KILL or RAMP
Trip	Max time "overcurrent" allowed to last (1000 = ∞)	s
IMon Range	Current Monitor Zoom	H or L
ZC Detect	Stores IMOn value (IMonZero) into memory for "zero current compensation" (remote control mode, 1471H only)	ON/OFF
ZC Adjust	Subtracts IMonZero from "non compensated" current value (remote control mode, 1471H only)	EN/DIS

To set one parameter, tap on the relevant name, and change and/or enter the desired value through the "virtual keypad" (see below); confirm with "Enter". Tap the red arrow to go back to Main Menu.

<b>1</b>	<b>2</b>	<b>3</b>
<b>4</b>	<b>5</b>	<b>6</b>
<b>7</b>	<b>8</b>	<b>9</b>
<b>.</b>	<b>0</b>	<b>Del</b>
<b>Enter</b>		

**Fig. 23: Virtual keypad**

Group Settings

GROUP MENU ←				GROUP MENU ←	
Ch	VMon	IMon	Status		
0(-)	1500.0	0000.00	On v	MaxV	8100
1(-)	0000.0	0000.00	Off v	RampUp	500
2(-)	0000.0	0000.00	Off v	RampDown	400
3(-)	0000.0	0000.00	Off v	Trip	INF
Zoom				RampDown	400
VSet				PowerDown	Kill
ISet				IMonRange	High
Chan		1/2		Chan	2/2

Fig. 24: Group Parameters

For the Group of all channels, the following parameters can be programmed and monitored either locally or remotely (see p.24):

Parameter:	Function:	Unit:
Vmon	High Voltage Monitored value single channels	Volt
Imon	Current Monitored value single channels	µA
Status	ON/OFF; Ramp UP/DOWN; OVV; UNV; OVC; OVP; MAXV; TRIP; OVT; OFF; KILL; ILK; CAL_ERR single channels	
Vset	High Voltage programmed value	Volt
Iset	Current Limit programmed value	µA
MaxV	Absolute maximum High Voltage level that the channel can reach	V
Ramp-Up	Maximum High Voltage increase rate	V/s
Ramp-Down	Maximum High Voltage decrease rate	V/s
Power Down	Power Down mode after channel TRIP	KILL or RAMP
Trip	Maximum time an "overcurrent" is allowed to last	s
IMon Range	Current Monitor Zoom	H or L
ZC Detect	Stores IMOn value (IMonZero) into memory for "zero current compensation" (remote control mode, 1471H only)	ON/OFF
ZC Adjust	Subtracts IMonZero from "non compensated" current value (remote control mode, 1471H only)	EN/DIS

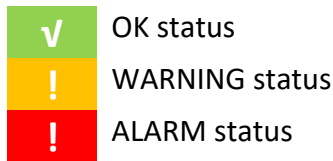
To set one parameter, tap on the relevant name, and change and/or enter the desired value through the "virtual keypad"; confirm with "Enter". Tap the red arrow to go back to Main Menu. "Zoom" option allows to display large sized Vmon and Imon values.

ZOOM MODE ←		
Ch0	5499.2	V
v	0000.00	µA
Ch0	0000.0	V
v	0000.00	µA
Ch0	0000.0	V
v	0000.00	µA
Ch0	0000.0	V
v	0000.00	µA

Fig. 25: Zoom Mode

## Status Icon

Three types of Icon in the display status area indicate:



## Current monitor offset calibration

The Units are calibrated by introducing a positive offset on the current monitor. This type of calibration allows to monitor very low current thus removing possible issues due to components and working temperatures related negative offsets. The absolute value of delivered current can be quantified by following the steps below:

- 1) Turn on the module, after a warm-up of about 30 minutes with operating voltage and load disconnected (no link between the unit and detectors) then read the monitored current value  $I_{mon} = I_1$  (offset)
- 2) Turn off the channel and connect the load
- 3) Turn on the channel with the same voltage set as point 1)
- 4) Wait a few minutes and read again the current value monitor  $I_{mon} = I_2$  (offset +  $I_{out}$ )
- 5) The value of current output is equal to the difference between  $I_2$  and  $I_1$  ( $I_{out} = I_2 - I_1$ )

Leakage currents equal to:

R-DT1419ET	1nA/100 V		Vout=400V, Imon=+6nA (2nA Offset +4nA current leakage/400V)
R-DT1470ET	5nA/1kV	Shall be	Vout=4kV, Imon=+30nA (10nA Offset +20nA current leakage/4kV)
R-DT1471ET	1nA/500V	tolerated; e.g.	Vout=2kV, Imon=+6nA (2nA Offset +4nA current leakage/2kV)
R-DT1471HET	0.1nA/500V		Vout=2kV, Imon=+0.6nA (0.2nA Offset +0.4nA current leakage/2kV)
R-DT1570ET			

The offset introduced is equal to:

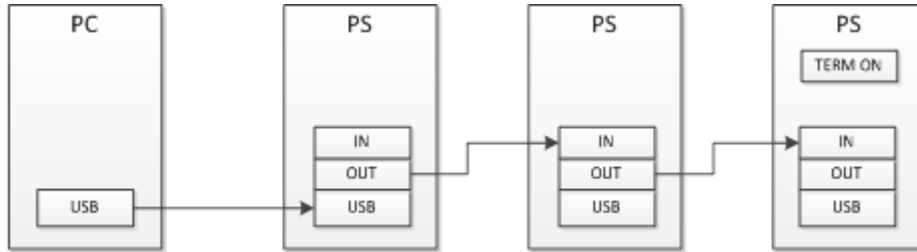
R-DT1419ET	20nA for high range; 2nA for low range
R-DT1470ET	100nA for high range; 10nA for low range
R-DT1471ET	20nA for high range; 2nA for low range
R-DT1471HET	2nA for high range; 0.2nA for low range
R-DT1570ET	

with output voltage at 10% of full scale and 20 °C temperature.

## Remote Control

Module control can take place remotely, via USB or Ethernet; the latter allows, using the RS485 I/O's, to build a daisy chain network. To turn ON the unit, connect the unit to the Mains through the provided power cord, and switch it ON; then go to Board menu and set Control > REMOTE (see p. 19).

### USB communication



**Fig. 26: USB communication diagram**

The module is provided with a USB2.0 compliant interface (see p.10). The Unit can be programmed via PC by connecting the PC USB port with the Unit USB B-type port; the relevant drivers, are available from [www.caen.it](http://www.caen.it) DT14xxET/R14xxET page.

N.B. for Linux OS Users: the Unit is automatically recognised by Kernel Linux 2.6.9 and higher; unit name is assigned to serial port with name `/dev/ttyACM[x]`, where `[x]` is device number; for example 1<sup>st</sup> module connected is `/dev/ttyACM0`, 2<sup>nd</sup> module is `/dev/ttyACM1` etc.

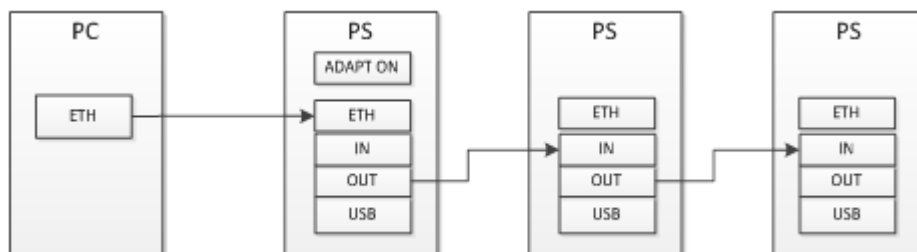
CAEN provides the CAEN GECO2020 Control Software that allows a friendly remote management of all Unit's functional parameters (see [www.caen.it](http://www.caen.it) software support page); anyway, the connection can be performed also via terminal emulator, such as Tera Term, configured as follows:

- baud rate 9600
- Data bits: 8
- Parity: none
- stop bit: 1
- Flow control: Xon Xoff

As the communication is running, type CAEN, and the main menu will be accessed (see p.25)

It is also possible to build a daisy chain of up to 32 units, with the first module connected to the PC USB port and the subsequent ones daisy chained through the COMM IN/OUT (this feature is not available on Mod. R1470ETD - 8 Channel) ; in this case communication with the chained modules is achieved through the USB - RS485 Communication Protocol, see p.29. All modules must be assigned a LOCAL BUS ADDRESS different from one another and the last one must be terminated (see p. 35)

### Ethernet communication



**Fig. 27: Ethernet communication diagram**

It is possible to communicate via Ethernet with one or more daisy chained DT14xxET/R14xxET modules. Communication via Ethernet is possible only through the USB - RS485 Communication Protocol. It is necessary to connect the 1<sup>st</sup> module to the PC via Ethernet, then the 1<sup>st</sup> module to the following using COMM IN/OUT. Daisy chain capability is not available on Mod. R1470ETD - (8 Channel).

CAEN provides the CAEN GECO2020 Control Software that allows a friendly remote management of all Unit's functional parameters (see [www.caen.it](http://www.caen.it) software support page); anyway, the connection can be performed also via terminal emulator, such as Tera Term.

### Ethernet configuration

To configure the Ethernet Port:

- connect to the module via USB as explained in the previous sections
- launch a terminal emulator, such as Tera Term, configured as explained at p.24
- type CAEN
- the following screen will open:

```

#####          ##      #####          ##          #####
##  ##          ##      ##      ##      ##      ##      ##
##  ##          ##      ##      ##      ##      ##      ##
#####          ##      ##      ##      ##      ##      ##

C.A.E.N. DT1471ET4 CH 5.5KV/300uA   V1.00   Addr 00

B O A R D   M E N U

Display          Display/Modify channels
Format           Reformat EEPROM
General          General board status
Ethernet         Ethernet configuration
Update          Firmware Update

Quit

Select Item
    
```

**Fig. 28: Terminal Board Menu**

Type E; the following screen will open:

```

C.A.E.N. DT1471ET 4 CH 5.5KV/300uA   Power Supply   V1.00   Addr 00

Ethernet Configuration Menu
MACAddress      00 1e c0 f2 40 09
IPAddress       192 168 000 001
Subnet Mask     255 255 255 000
Gateway         255 255 255 255

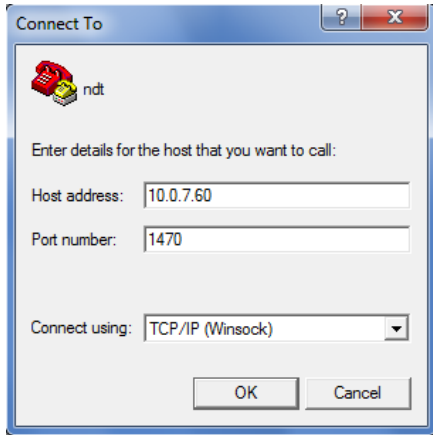
DHCP            Disabled

_Save   Quit
    
```

**Fig. 29: Terminal Ethernet settings**

At first Power On the module is configured with default static IP (factory setting); such IP can be updated using the I(PAddress), M(ask) or G(ate) to select the fields, typing the new values and confirming with <Enter>.

Type S to save the new setting in the EEPROM and go back to Main Menu, Q to go back without changes. When accessing via Ethernet select port number 1470; refer to figure:



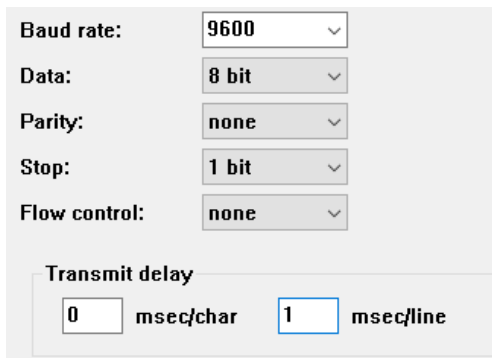
**Fig. 30: Terminal Ethernet connection**

The new setting will become active at next Power On; if a DHCP Server is available, then the module can be enabled or disabled as DHCP client; type S to save the new setting in the EEPROM and go back to Main Menu: the DHCP server will automatically assign a new IP to the module at next Power On.

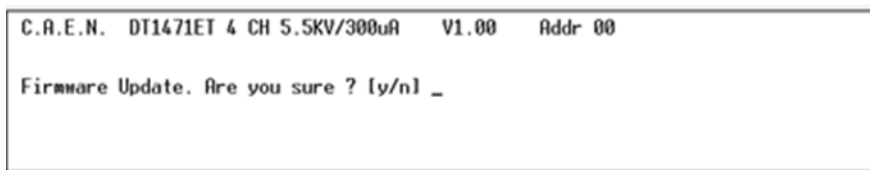
### Firmware upgrade

To upgrade the firmware:

- download from [www.caen.it](http://www.caen.it) product page the most recent firmware revision for your module
- connect to the module via USB using Tera Term VT Emulator
- in the Tera Term options, select “set up” > “serial port” and enter the following settings

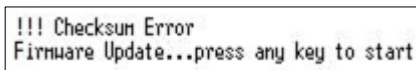


- click OK to confirm
- go to Terminal Board Menu (Fig. 28)
- type U to upgrade the firmware:

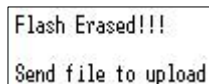


**Fig. 31: Firmware Upgrade Menu**

- Type y
- the following message will be shown:



- Press any key
- Wait until the following message is shown:



- Select “File” > send file
- Browse the image file
- Select “open”
- Wait the upload to complete
- turn OFF and then ON the module

now the unit is ready to operate running the upgraded firmware

### Format EEPROM

By typing F on Terminal Board Menu (Fig. 28) it is possible to access the format EEPROM menu.

```
C.A.E.N. DT1471ET 4 CH 5.5KV/300uA V1.00 Addr 00

Format EEPROM. Are you sure ? [y/n]
```

Fig. 32: Format EEPROM Menu

### Channels settings

By typing D on Terminal Board Menu (Fig. 28) it is possible to access channels settings

```
C.A.E.N. DT1471ET 4 CH 5.5KV/300uA Power Supply V1.00 Addr 00

          Ch0          Ch1          Ch2          Ch3
Polarity          -          -          -          -
Vmon          0000.0 V          0000.0 V          0000.0 V          0000.0 V
Imon          000.000 uA          000.000 uA          000.000 uA          000.000 uA
Status          Kill
Power          Off          Off          Off          Off
Vset          1000.0 V          2000.0 V          3000.0 V          2000.0 V
Iset          031.000 uA          310.000 uA          310.000 uA          310.000 uA
Maxv          5600 V          5600 V          5600 V          5600 V
Ramp Up          100 V/S          100 V/S          100 V/S          100 V/S
Ramp Down          200 V/S          200 V/S          200 V/S          200 V/S
Trip          010.0 S          010.0 S          010.0 S          010.0 S
Power Down          Kill          Kill          Kill          Kill
Imon Range          High          High          High          High

Group Mode      Reset Alarm      Quit
```

Fig. 33: Channels Menu

In order to change one parameter: point the parameter with the arrow keys, and type the desired value, confirm by pressing <Enter>; Power, Imon Range and Power Down can be changed using the <Space> bar.

### Board Status

By typing G on Terminal Board Menu (Fig. 28) it is possible to monitor the General Board Status

```
C.A.E.N. DT1470 4 CH 8KV/3mA V1.01 Addr 00
Serial Number      : 48
Local Bus Termination : OFF
Interlock Active   : CLOSED
Internal Supply    : OK
Over Power         : NO
HV Clock Status    : OK

Press 'I' to change Interlock Mode or any key to quit._
```

**Fig. 34: General Board Status**

## Communication Protocol

The following Protocol allows to communicate with up to 32 daisy chained modules. The Protocol is based on commands made of ASCII characters strings.

### Command Format

The Format of a command string is the following :

**\$BD:\*\* ,CMD:\*\*\* ,CH\* ,PAR:\*\*\* ,VAL:\*\*\* .\*\* <CR, LF >**

The fields that form the command are :

**BD** : 0..31 module address (to send the command)

**CMD** : MON, SET

**CH** : 0..NUMCH (NUMCH=4 for 4 channel units, NUMCH=8 for 8 channel units)

**PAR** : (see parameters tables)

**VAL** : (numerical value must have a Format compatible with resolution and range)

### Format of response string

#### Format response in case of error

String	Function (Units)
#BD:** ,CMD:ERR	Wrong command Format or command not recognized
#BD:** ,CH:ERR	Channel Field not present or wrong Channel value
#BD:** ,PAR:ERR	Field parameter not present or parameter not recognized
#BD:** ,VAL:ERR	Wrong set value (<Min or >Max)
#BD:** ,LOC:ERR	Command SET with module in LOCAL mode

Each string is terminated by < CR, LF >

#### Format response in case of correct command

String	Function (Units)
#BD:** ,CMD:OK	command Ok
#BD:** ,CMD:OK,VAL:*	command Ok * = value for command to individual Channel
#BD:** ,CMD:OK,VAL:*,*,*,*	command Ok *,*,*,* = values Ch0..NUMCH for command to all Channels

Numerical value Field 'VAL' has Format compatible (comma and decimal part) with the resolution and the range related to the parameter. Each string is terminated by < CR, LF >

### MONITOR commands related to the Channels

The following table contains the strings to be used to handle monitor commands related to the Channels. The 'X' in the Field 'Channel' can be set in the '0..NUMCH' range.

When 'X=NUMCH' the module returns the values of the parameter of all Channels.

String	Function (Units)
\$BD:xx,CMD:MON,CH:X,PAR:VSET	Read out VSET value
\$BD:xx,CMD:MON,CH:X,PAR:VMIN	Read out VSET minimum value
\$BD:xx,CMD:MON,CH:X,PAR:VMAX	Read out VSET maximum value
\$BD:xx,CMD:MON,CH:X,PAR:VDEC	Read out VSET number of decimal digits
\$BD:xx,CMD:MON,CH:X,PAR:VMON	Read out VMON value
\$BD:xx,CMD:MON,CH:X,PAR:ISET	Read out ISET value ( $\mu$ A )
\$BD:xx,CMD:MON,CH:X,PAR:IMIN	Read out ISET minimum value ( $\mu$ A )
\$BD:xx,CMD:MON,CH:X,PAR:IMAX	Read out ISET max value
\$BD:xx,CMD:MON,CH:X,PAR:ISDEC	Read out ISET number of decimal digits
\$BD:xx,CMD:MON,CH:X,PAR:IMON	Read out IMON value ( $\mu$ A )
\$BD:xx,CMD:MON,CH:X,PAR:IMRANGE	Read out IMON RANGE value ( HIGH / LOW )

String	Function (Units)
\$BD:xx,CMD:MON,CH:X,PAR:IMDEC	Read out IMON number of decimal digits
\$BD:xx,CMD:MON,CH:X,PAR:MAXV	Read out MAXVSET value
\$BD:xx,CMD:MON,CH:X,PAR:MVMIN	Read out MAXVSET minimum value ( 0 V )
\$BD:xx,CMD:MON,CH:X,PAR:MVMAX	Read out MAXVSET maximum value
\$BD:xx,CMD:MON,CH:X,PAR:MVDEC	Read out MAXVSET number of decimal digits
\$BD:xx,CMD:MON,CH:X,PAR:RUP	Read out RAMP UP value ( V/S )
\$BD:xx,CMD:MON,CH:X,PAR:RUPMIN	Read out RAMP UP minimum value ( V/S )
\$BD:xx,CMD:MON,CH:X,PAR:RUPMAX	Read out RAMP UP maximum value
\$BD:xx,CMD:MON,CH:X,PAR:RUPDEC	Read out RAMP UP number of decimal digits
\$BD:xx,CMD:MON,CH:X,PAR:RDW	Read out RAMP DOWN value ( V/S )
\$BD:xx,CMD:MON,CH:X,PAR:RDWMIN	Read out RAMP DOWN minimum value ( V/S )
\$BD:xx,CMD:MON,CH:X,PAR:RDWMAX	Read out RAMP DOWN maximum value
\$BD:xx,CMD:MON,CH:X,PAR:RDWDEC	Read out RAMP DOWN number of decimal digits
\$BD:xx,CMD:MON,CH:X,PAR:TRIP	Read out TRIP time value ( S )
\$BD:xx,CMD:MON,CH:X,PAR:TRIPMIN	Read out TRIP time minimum value ( S )
\$BD:xx,CMD:MON,CH:X,PAR:TRIPMAX	Read out TRIP time maximum value ( S )
\$BD:xx,CMD:MON,CH:X,PAR:TRIPDEC	Read out TRIP time number of decimal digits
\$BD:xx,CMD:MON,CH:X,PAR:PDWN	Read out POWER DOWN value ( RAMP / KILL )
\$BD:xx,CMD:MON,CH:X,PAR:POL	Read out POLARITY value ( '+' / '-' )
\$BD:xx,CMD:MON,CH:X,PAR:STAT	Read out Channel status value ( XXXXX )
\$BD:xx,CMD:MON,CH:X,PAR:ZCDTC	Status of ZC Detect; ON = offset current is getting stored; OFF = ready to store offset current (Available only on 1471H series)
\$BD:xx,CMD:MON,CH:X,PAR:ZCADJ	Status of ZC Adjust (EN/DIS) (Available only on 1471H series)

**Meaning of STATUS bits (value read in decimal Format)**

Bit	Function
Bit 0 → ON	1 : ON 0 : OFF
Bit 1 → RUP	1 : Channel Ramp UP
Bit 2 → RDW	1 : Channel Ramp DOWN
Bit 3 → OVC	1 : IMON >= ISET
Bit 4 → OVV	1 : VMON > VSET + 2.5 V
Bit 5 → UNV	1 : VMON < VSET - 2.5 V
Bit 6 → MAXV	1 : VOUT in MAXV protection
Bit 7 → TRIP	1 : Ch OFF via TRIP (Imon >= Iset during TRIP)
Bit 8 → OVP	1 : Output Power > Max
Bit 9 → OVT	1: TEMP > 105°C
Bit 10 → DIS	1 : Ch disabled (REMOTE Mode and Switch on OFF position)
Bit 11 → KILL	1 : Ch in KILL via front panel
Bit 12 → ILK	1 : Ch in INTERLOCK via front panel
Bit 13 → NOCAL	1 : Calibration Error
Bit 14, 15 → N.C.	

**MONITOR commands related to the module**

The following table shows the strings to be used to handle monitor commands related to the module.

String	Function (Units)
\$BD:xx,CMD:MON,PAR:BDNAME	Read out module name
\$BD:xx,CMD:MON,PAR:BDNCH	Read out module Channels number
\$BD:xx,CMD:MON,PAR:BDFREL	Read out Firmware Release
\$BD:xx,CMD:MON,PAR:BDSNUM	Read out module serial number

String	Function (Units)
\$BD:xx,CMD:MON,PAR:BDILK	Read out INTERLOCK status ( YES/NO )
\$BD:xx,CMD:MON,PAR:BDILKM	Read out INTERLOCK mode ( OPEN/CLOSED )
\$BD:xx,CMD:MON,PAR:BDCTR	Read out Control Mode ( LOCAL / REMOTE )
\$BD:xx,CMD:MON,PAR:BDTERM	Read out LOCAL BUS Termination status ( ON/OFF )
\$BD:xx,CMD:MON,PAR:BDALARM	Read out Board Alarm status value ( XXXXX )

### Meaning of Board Alarm bits

Bit	Function
Bit 0 → CH0	1 : Ch0 in Alarm status
Bit 1 → CH1	1 : Ch1 in Alarm status
Bit 2 → CH2	1 : Ch2 in Alarm status
Bit 3 → CH3	1 : Ch3 in Alarm status
Bit 4 → PWFAIL	1 : Board in POWER FAIL
Bit 5 → OVP	1 : Board in OVER POWER
Bit 6 → HVCKFAIL	1 : Internal HV Clock FAIL ( ≠ 200±10kHz )

### SET commands related to the Channels

The following table contains the strings to be used to handle set commands related to the Channels. The 'X' in the Field 'Channel' can be set to the '0..NUMCH' range. When 'X=NUMCH' the command is issued to all Channels.

String	Function (Units)
\$BD:xx,CMD:SET,CH:X,PAR:VSET,VAL:value	Set VSET value
\$BD:xx,CMD:SET,CH:X,PAR:ISET,VAL:value	Set ISET value
\$BD:xx,CMD:SET,CH:X,PAR:MAXV,VAL:value	Set MAXVSET value
\$BD:xx,CMD:SET,CH:X,PAR:RUP,VAL:value	Set RAMP UP value
\$BD:xx,CMD:SET,CH:X,PAR:RDW,VAL:value	Set RAMP DOWN value
\$BD:xx,CMD:SET,CH:X,PAR:TRIP,VAL:value	Set TRIP time value
\$BD:xx,CMD:SET,CH:X,PAR:PDWN,VAL:RAMP/KILL	Set POWER DOWN mode
\$BD:xx,CMD:SET,CH:X,PAR:IMRANGE,VAL:HIGH/LOW	Set IMON RANGE
\$BD:xx,CMD:SET,CH:X,PAR:ON	Set Ch ON
\$BD:xx,CMD:SET,CH:X,PAR:OFF	Set Ch OFF
\$BD:xx,CMD:SET,CH:X,PAR:ZCADJ,VAL:EN	The stored IMonZero value via ZCDetect option is subtracted from the measured, "non compensated" IMON value. The returned "compensated" IMON value will be then the difference between measured and stored values; (Available only on 1471H series)
\$BD:xx,CMD:SET,CH:X,PAR:ZCADJ,VAL:DIS	The returned IMON value is not compensated (Available only on 1471H series)

### SET commands related to the module

String	Function (Units)
\$BD:xx,CMD:SET,PAR:BDILKM,VAL:OPEN/CLOSED	Set Interlock Mode
\$BD:xx,CMD:SET,PAR:BDCLR	Clear alarm signal

## EPICS Service

EPICS (Experimental Physics and Industrial Control System) is a set of software tools and applications which provide a software infrastructure for use in building distributed control systems, widely used to control experimental Physics and industrial electronics.

CAEN provides EPICS Input/Output Controller (IOC) for 19" and DeskTop HV Power Supplies, that allows access to a Process Variable using the Channel Access Protocol. Process Variable is a named piece of data associated with the module (e.g. status, readback, setpoint, parameter).

Client software (EPICS Channel Access Client), which requests access to a Process Variable, runs on the Host PC and is connected to the modules via either TCP/IP or USB.

The EPICS IOC is available for free download on [www.caen.it](http://www.caen.it) website (Power Supply Software section)

More information about EPICS and a list of available client applications can be found at:

<http://www.aps.anl.gov/epics/>.

# 5 Internal Settings

## Polarity selection

The output polarity is independently selectable for each channel. Note that the polarity is indicated by two LEDs for each channel on the front panel (see p. 12).

To change the polarity:

- Wear Antistatic Gloves
- Switch off the unit.
- Wait for the complete discharge of the capacitors.
  - Desktop: Remove screws that keep in place the top cover; four on the sides (two on each side, and one front)

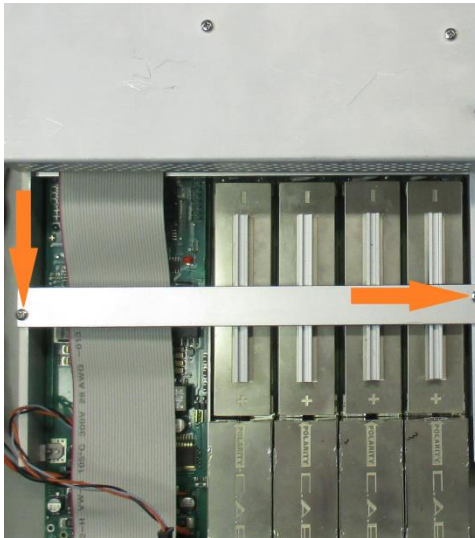


- 19": Remove screws that keep in place the top cover; six on the sides (three on each side, and one front)



- Lift the top cover gently
- Remove screws that keep in place the protection bar:

**14xx series**



**1570 series**



- Remove the bar

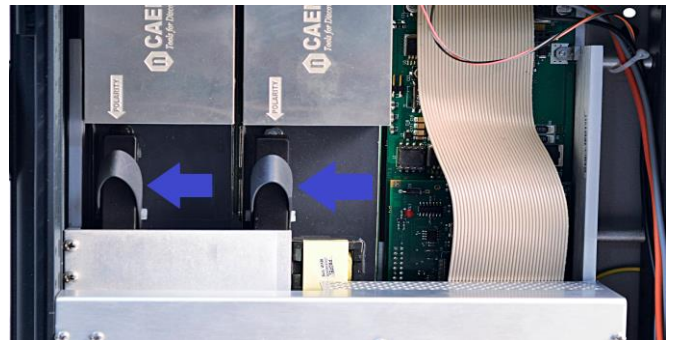
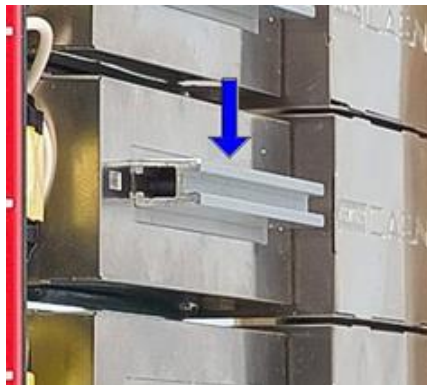
At this point it is possible to change the channel polarity: refer to the following figure (the blue arrow indicates diode bridge box placed to configure channel as POSITIVE).

During this operation pay attention not to bend the pins, when plugging them completely in their sockets



**14xx series**

**1570 series**



**Fig. 35: Polarity selection instructions**

- To choose the POSITIVE POLARITY, plug the diode bridge box, with the + symbol towards the connector side.
- To choose the NEGATIVE POLARITY, plug the diode bridge box, with the - symbol towards the connector side.
- Always pull and plug the diode bridge box by holding it on the handle pointed by the arrow in Fig. above.
- Once settings are done, put the bars (insulated side towards diode boxes) and covers back in place with the screws.

## Local Bus termination

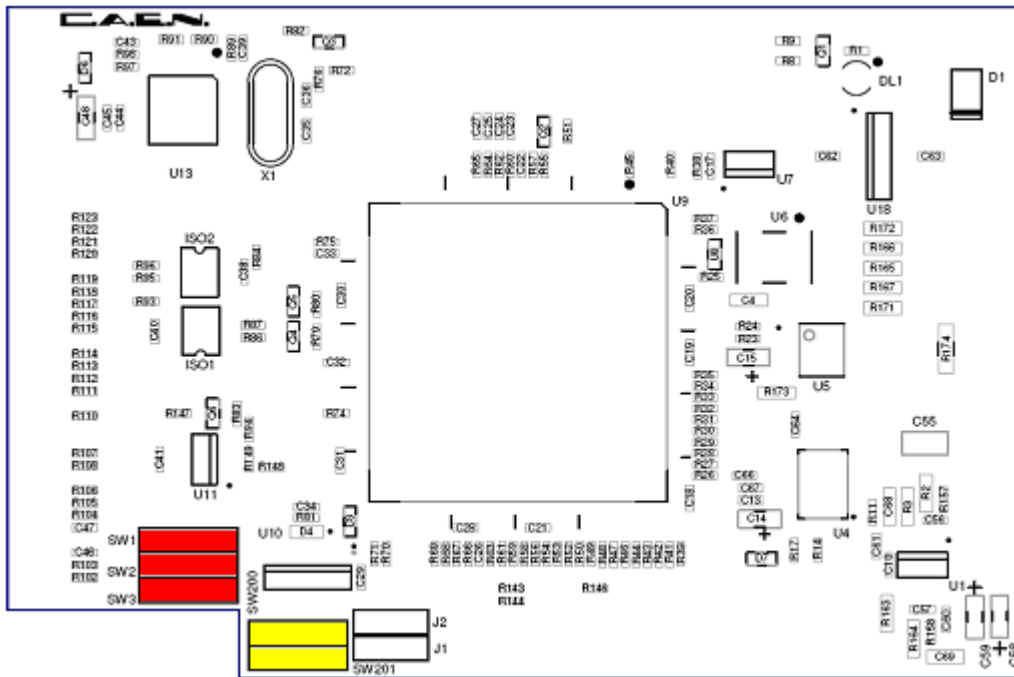


Fig. 36: Dip switch position

The SW[1..3] switch placed on the Microcontroller board inside the module (behind the *Remote communication control section*), allows to terminate the Local Bus for daisy chain purposes; dot NOT visible = Termination ON.

## Grounding specifications

The unit's channels share a common floating return (FAGND), insulated from the crate ground (AGND). This feature allows on-detector grounding, thus avoiding loops which may increase noise level. FAGND and AGND may be connected, by short circuiting C21 jumper pins on the motherboard (see figure below). The protection shield must be screwed off to access C21 (see p.33 Polarity selection).

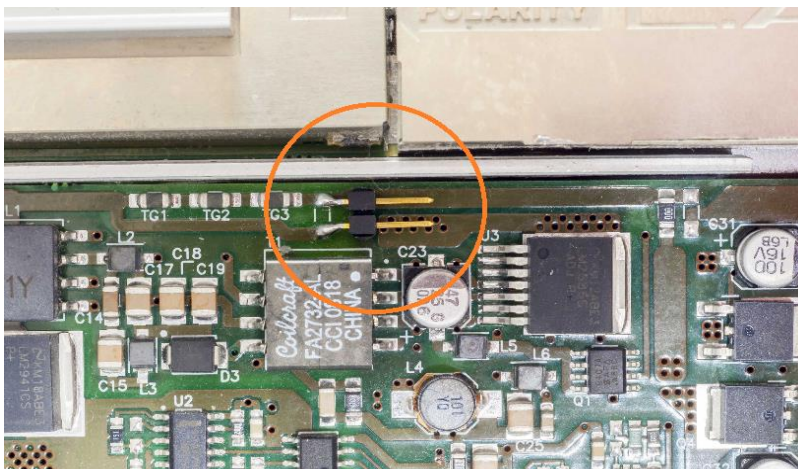


Fig. 37: C21 jumper location

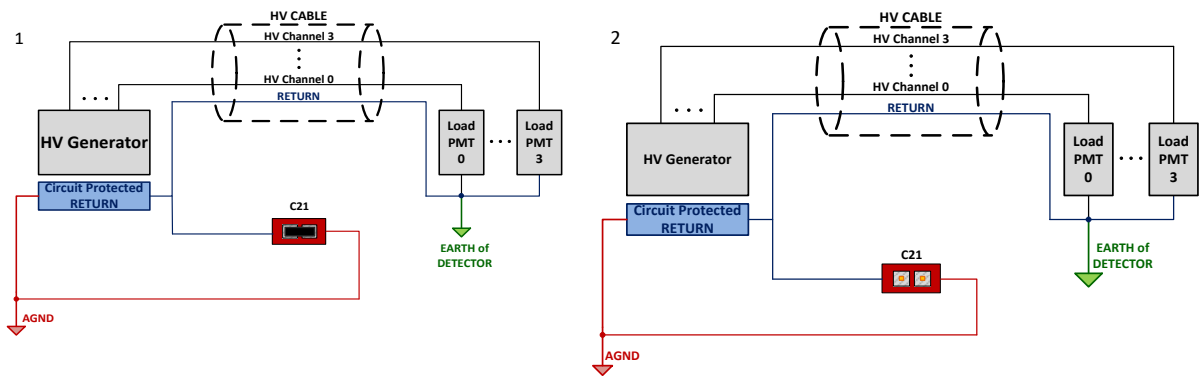
## Safety Earth connection

The connection of return to Earth is fundamental for User safety. The connection must always be at the level of detector or power supply system.

Return connection even if not present or performed incorrectly, due to protection circuits implemented on the unit, are bound to Earth; in this case the voltage difference between return and Earth (System), is limited to approximately 50V. Please note that this is a status of emergency-protection, not a working one. The Connector Configurator allows to optimize the connection of the return and of AGND (Earth). The best configuration must be determined by the user upon application, the optimal connection depends on many characteristics of the related experiment.

The following diagrams show two examples of configuration, namely:

1. The “closed loop” Earth configuration (C21 contacts closed)
2. The “open loop” Earth configuration (C21 contacts open)



**Fig. 38: Earth configuration connection examples**

## 6 Instructions for Cleaning

The equipment may be cleaned with isopropyl alcohol or deionized water and air dried. Clean the exterior of the product only.

Do not apply cleaner directly to the items or allow liquids to enter or spill on the product.

### Cleaning the Touchscreen

To clean the touchscreen (if present), wipe the screen with a towelette designed for cleaning monitors or with a clean cloth moistened with water.

Do not use sprays or aerosols directly on the screen; the liquid may seep into the housing and damage a component. Never use solvents or flammable liquids on the screen.

### Cleaning the air vents

It is recommended to occasionally clean the air vents (if present) on all vented sides of the board. Lint, dust, and other foreign matter can block the vents and limit the airflow. Be sure to unplug the board before cleaning the air vents and follow the general cleaning safety precautions.

### General cleaning safety precautions

CAEN recommends cleaning the device using the following precautions:

- Never use solvents or flammable solutions to clean the board.
- Never immerse any parts in water or cleaning solutions; apply any liquids to a clean cloth and then use the cloth on the component.
- Always unplug the board when cleaning with liquids or damp cloths.
- Always unplug the board before cleaning the air vents.
- Wear safety glasses equipped with side shields when cleaning the board

## 7 Device decommissioning

After its intended service, it is recommended to perform the following actions:

- Detach all the signal/input/output cable
- Wrap the device in its protective packaging
- Insert the device in its packaging (if present)



**THE DEVICE SHALL BE STORED ONLY AT THE ENVIRONMENT CONDITIONS SPECIFIED IN THE MANUAL, OTHERWISE PERFORMANCES AND SAFETY WILL NOT BE GUARANTEED**

## 8 Disposal

The disposal of the equipment must be managed in accordance with Directive 2012/19 / EU on waste electrical and electronic equipment (WEEE).



The crossed bin symbol indicates that the device shall not be disposed with regular residual waste.

## 9 Technical Support

To contact CAEN specialists for requests on the software, hardware, and board return and repair, it is necessary a MyCAEN+ account on [www.caen.it](http://www.caen.it):

<https://www.caen.it/support-services/getting-started-with-mycaen-portal/>

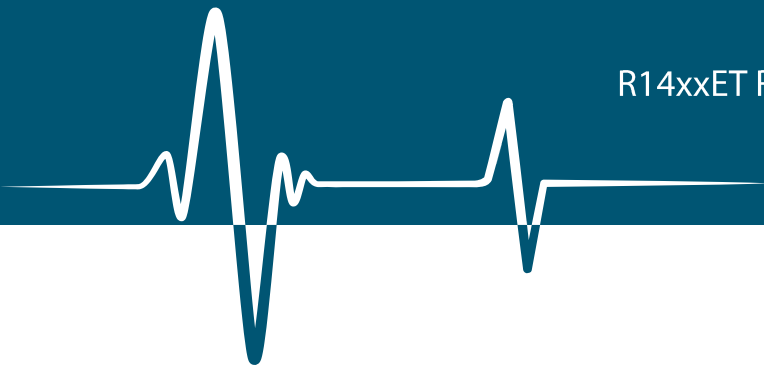
All the instructions for use the Support platform are in the document:



A paper copy of the document is delivered with CAEN boards.

The document is downloadable for free in PDF digital format at:

[https://www.caen.it/wp-content/uploads/2022/11/Safety\\_information\\_Product\\_support\\_W.pdf](https://www.caen.it/wp-content/uploads/2022/11/Safety_information_Product_support_W.pdf)



**CAEN S.p.A.**  
Via Vetraia 11  
55049 - Viareggio  
Italy  
Phone +39 0584 388 398  
Fax +39 0584 388 959  
info@caen.it  
[www.caen.it](http://www.caen.it)



**CAEN GmbH**  
Eckehardweg 10  
42653 - Solingen  
Germany  
Phone +49 212 254 40 77  
Fax +49 212 254 40 79  
info@caen-de.com  
[www.caen-de.com](http://www.caen-de.com)

**CAEN Technologies, Inc.**  
1 Edgewater Street - Suite 101  
Staten Island, NY 10305  
USA  
Phone: +1 (718) 981-0401  
Fax: +1 (718) 556-9185  
info@caentechnologies.com  
[www.caentechnologies.com](http://www.caentechnologies.com)

**CAENspa INDIA Private Limited**  
B205, BLDG42, B Wing,  
Azad Nagar Sangam CHS,  
Mhada Layout, Azad Nagar, Andheri (W)  
Mumbai, Mumbai City,  
Maharashtra, India, 400053  
info@caen-india.in  
[www.caen-india.in](http://www.caen-india.in)



User Manual 3372 - R14xxET R1570ET 19" & DT14xxET DT1570ET DeskTop HV Power Supplies rev. 20 - April 12th, 2024

00112/07:x1470.MUTx

Copyright © CAEN SpA. All rights reserved. Information in this publication supersedes all earlier versions. Specifications subject to change without notice.